

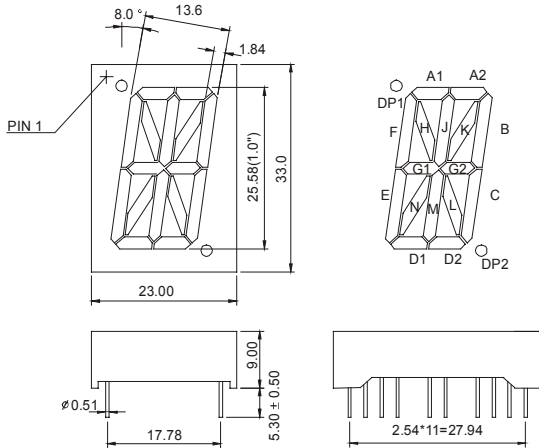

MCD-10013Ax-Bx (SINGLE DIGIT LED DISPLAY)

MCD-10013 Series



MCD-10013Ax

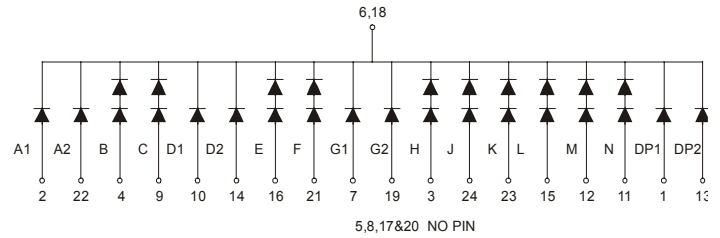

MCD-10013Bx

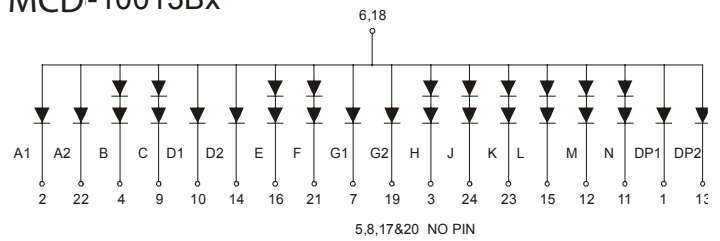

Features:

*1.0 INCH HIGH CHARACTER.

*EXCELLENT CHARACTER APPEARANCE.

*COMMON CATHODE OR COMMON ANODE.

*I.C. COMPATIBLE

*LOW POWER CONSUMPTION.

| Part Number | EMITTED COLOR | | Common Cathode or Common Anode | Peak Wavelength (nm) | Vf (v) Typ | If (mA) | Intensity Per Segment (mcd) | |
|--------------|---------------|--------------|--------------------------------------|----------------------------|------------------|------------|-----------------------------------|------|
| | | | | | | | Min. | Typ. |
| MCD-10013AE | GaAsP/GaP | Hi. effi Red | Common Cathode | 635 | 2.0 | 20 | 18 | 24 |
| MCD-10013AG | GaP | Green | | 565 | 2.1 | 20 | 16 | 22 |
| MCD-10013AY | GaAsP/GaP | Yellow | | 585 | 2.0 | 20 | 18 | 24 |
| MCD-10013AS | GaAlAs | Super Red | | 660 | 1.8 | 20 | 20 | 26 |
| MCD-10013AD | GaAlAs | Ultras Red | | 660 | 1.8 | 20 | 50 | 60 |
| MCD-10013AUE | AlGaInP | Ultra Red | | 625 | 2.0 | 20 | 60 | 70 |
| MCD-10013AUY | AlGaInP | Ultra Yellow | | 590 | 2.0 | 20 | 60 | 70 |
| MCD-10013BE | GaAsP/GaP | Hi. effi Red | Common Anode | 635 | 2.0 | 20 | 18 | 24 |
| MCD-10013BG | Gap | Green | | 565 | 2.1 | 20 | 16 | 22 |
| MCD-10013BY | GaAsP/GaP | Yellow | | 585 | 2.0 | 20 | 18 | 24 |
| MCD-10013BS | GaAlAs | Super Red | | 660 | 1.8 | 20 | 20 | 26 |
| MCD-10013BD | GaAlAs | Ultras Red | | 660 | 1.8 | 20 | 50 | 60 |
| MCD-10013BUE | AlGaInP | Ultra Red | | 625 | 2.0 | 20 | 60 | 70 |
| MCD-10013BUY | AlGaInP | Ultra Yellow | | 590 | 2.0 | 20 | 60 | 70 |